

Digital LED Signage solutions for business
Motion LED display
Commercial LED display

2020 COLLECTION

TOTEM – indoor and outdoor LED display



- Integrate R&D, design, manufacturing, sales and service.
- NSE Providing LED poster solutions with unique design and stable performance
- Light Weight & Ultra-thin Frame
- Smart Control & Multiple-unit Cascade
- Wide Applicability, Indoor and Outdoor Models Available
- Fast Delivery, in stock ready for shipment

▶ STABLE PERFORMANCE

Wide operating temperature range (-40°C ~ +75°C) and high humidity resistant



The NSELED Totem Series has FCC/CE/ROHS/ISO Certifications.

Aging test



Quality Control check before shipping



Vibration test



▶ SMART CONTROL

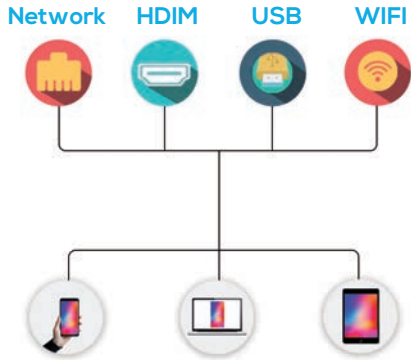

- Synchronous & Asynchronous Dual-mode Media Player
- Real-time Zoom In And Out
- 8 GB Memory
- Supports USB Expansion
- With HDMI Interface and Audio Port

This picture depicts a detail of the Indoor Totem

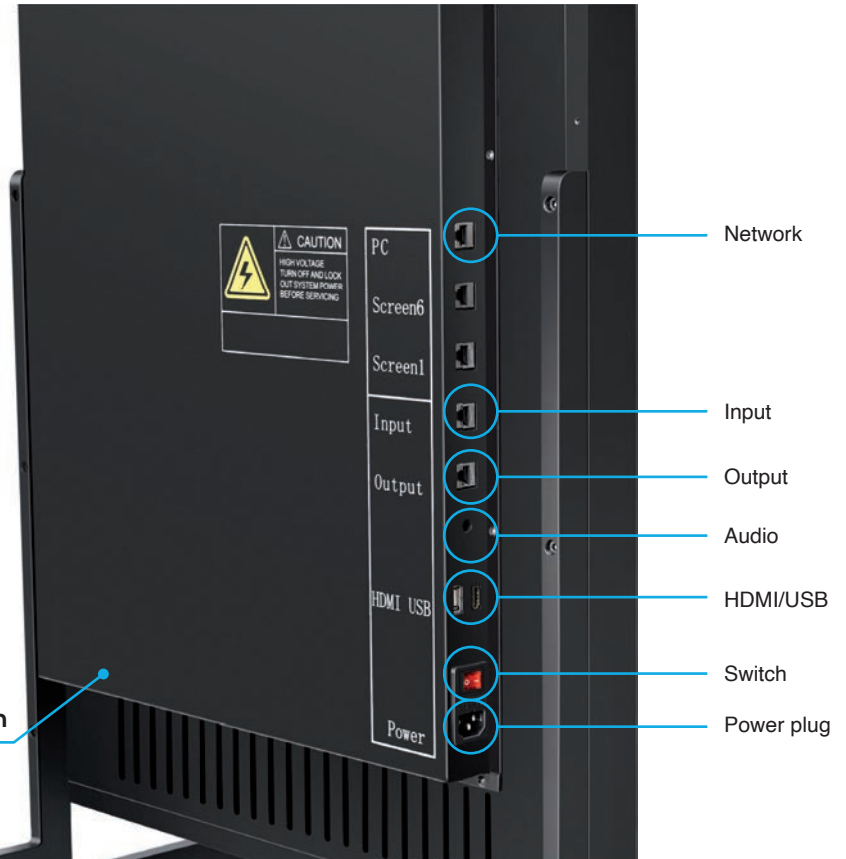

▶ MULTIPLE INSTALLATION METHOD

ONE DEVICE FOR MULTIPLE USES

Free - Standing



Wall - Mounted



Hanging



Creative Stitching



▶ PLUG AND PLAY

Our Totems are designed to be user-friendly: no complicated setting to fix, no new devices to buy to have a thorough experience, no particular skills needed to be capable of using them.

You just have to plug them in and they are good to go!

Can automatically play video, pictures, text, and other programs.



▶ MULTI - SCREEN SPLICING

- MULTIPLE-UNIT SPLICING
- ULTRA-HIGH RESOLUTION
- ULTRA-THIN
- LIGHT&SLIM

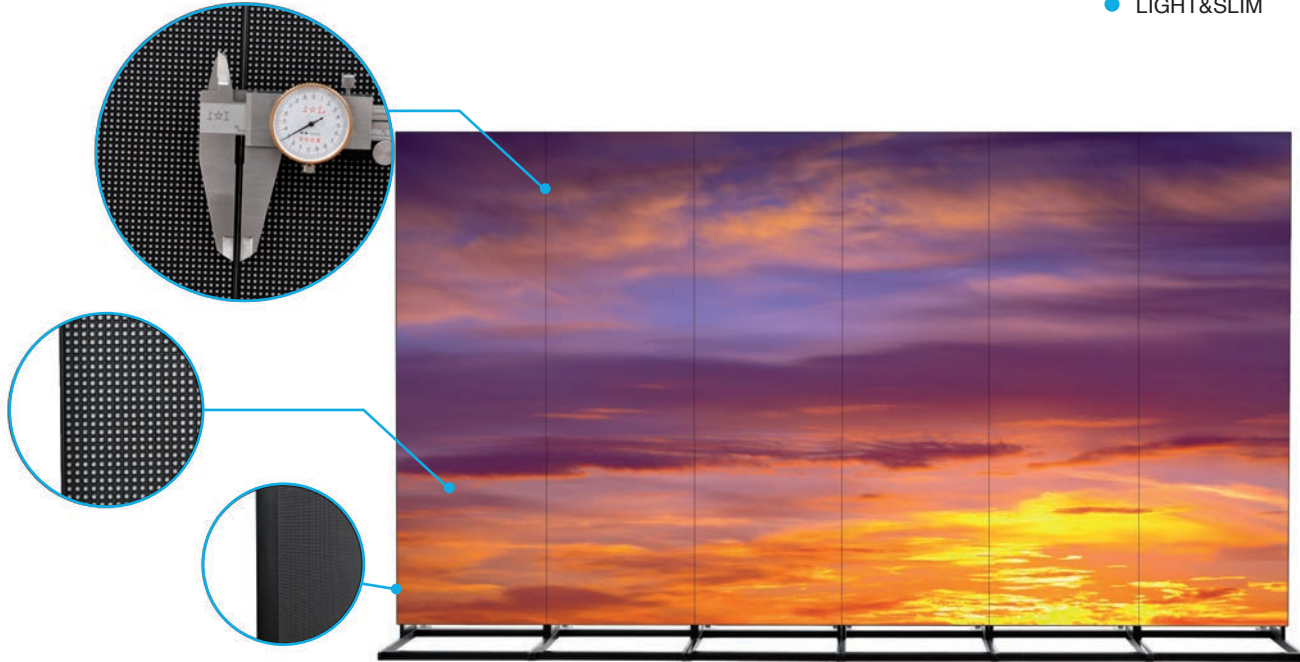

▶ APPLICABILITY

- SHOPPING MALLS 
- HOTELS 
- BANK 
- BARS 
- STORES 
- HOSPITAL 
- RESTAURANTS 
- SCHOOL 
- EXHIBITIONS 
- EVENTS 



▶ LIGHT WEIGHT& ULTRA - THIN

TOTEM P3
INDOOR DIGITAL LED DISPLAY



57 cm

35 KG

TOTEM P2.5
INDOOR DIGITAL LED DISPLAY



64 cm

38 KG

TOTEM P2
INDOOR DIGITAL LED DISPLAY



77 cm

46 KG



▶ INDOOR AND OUTDOOR LED DISPLAY

TOTEM OUTDOOR



BRIGHTNESS



WATERPROOF

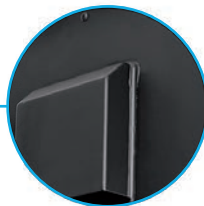
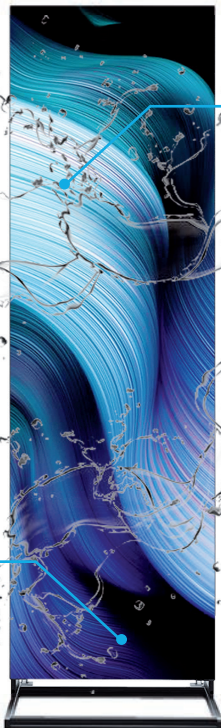

TOTEM INDOOR



BRIGHTNESS

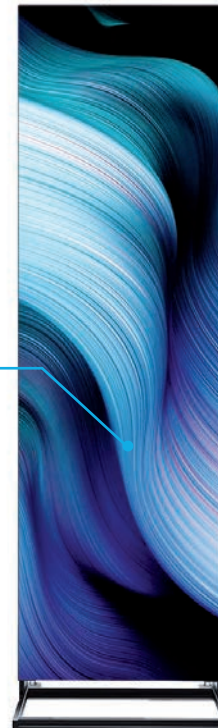

▶ WATER-RESISTANT & EASY TO HANDLE

- LIGHTWEIGHT
- THIN FRAME
- EASY TO MOVE

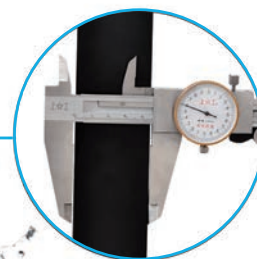

38 KG



▶ EXTERNAL DEVICE COMPATIBLE

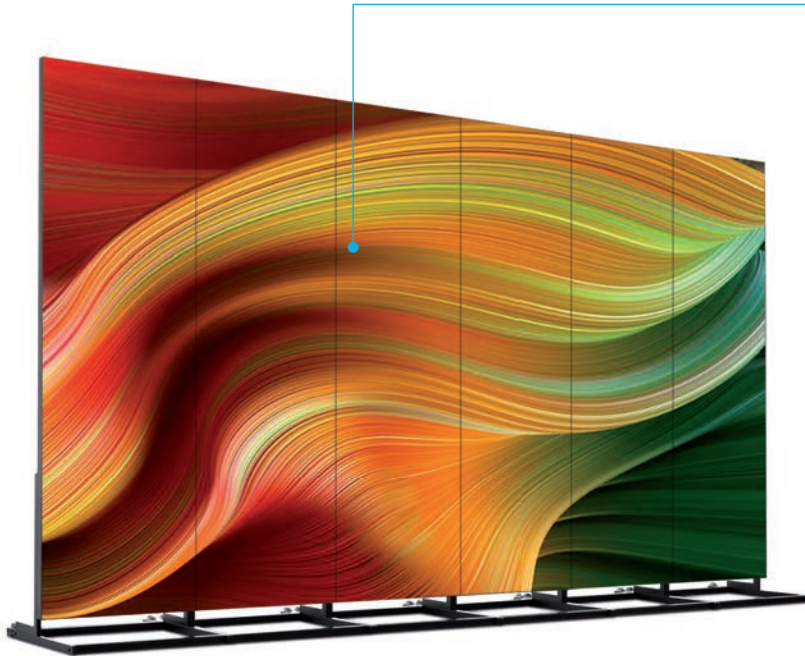

Connect the external light sensor to automatically adjust the screen brightness according to the environment

▼
Energy Saving

Connect with the speaker

▼
Make Your Ads Impressive And Unforgettable

Support interactive function(customizable)

▼
Better Advertising Effect

◀ BRIGHTNESS AUTOMATIC ADJUSTMENT

To achieve a better advertising effect, Totem is designed to be connected with the speaker. Totem can also support interactive functions (customizable).

▶ SERVICE

We have a stable supply chain system. Which not only guarantees the product quality but is also more competitive in terms of lead time.

We will do our best to meet your project requirements.

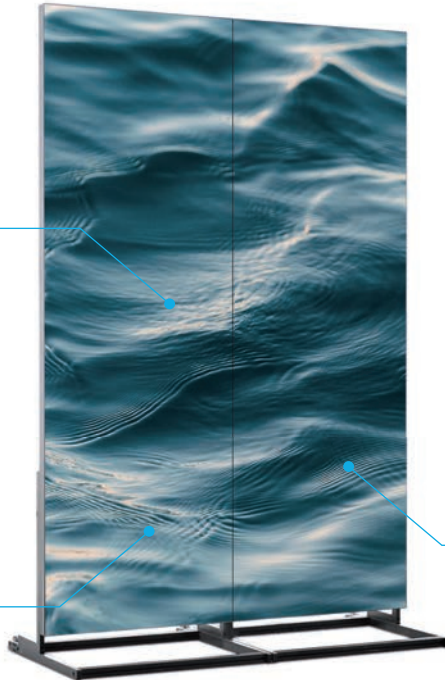

Hot-selling items are always in stock

▼
Customers don't have to wait for more than 10 days of production time.

We have freight forwarders that have cooperated for many years

▼
Give the most cost-effective freight plan faster.



- CUSTOM SIZE
- OPERATING SYSTEM

TOTEM INDOOR SPECIFICATION

Model Type	PT2	PT2.5	PT3
Application	Indoor/ Semi-Outdoor	Indoor/ Semi-Outdoor	Indoor/ Semi-Outdoor
Pixel pitch	2mm	2.5mm	3 mm
Density	250,000 dots /SQM	160,000 dots /SQM	111,111 dots /SQM
LED Type	SMD1515 Mat Black	SMD 2121 Mat Black	SMD 2121 Mat Black
Pixel type(R / G / B)	1R1G1B (3 in 1)	1R1G1B (3 in 1)	1R1G1B (3 in 1)
Module size	256 x 128mm	160 x 160mm	192 x 192mm
Module Resolution	128*64pixel	64*64pixel	64*64 pixel
Screen Size (H*W)	768*1920mm	640*1920mm	576*1920mm
Feet Size	2.52 * 6.3 feet	2.10* 6.3 feet	1.88 * 6.3 feet
Screen Resolution	384 * 960 pixel	256 * 768 pixel	192 * 640 pixel
Frame Size	1930mm(H)*776mm(W)*45mm(T)	1930mm(H)*648mm(W)*45mm(T)	1930mm(H)*584mm(W)*45mm(T)
Case Material	Aluminum	Aluminum	Aluminum
Weight	46kg/ unit	38kg/ unit	35kg/ unit
Drive mode	1/32 Scan	1/32 Scan	1/16 Scan
Viewing Distance	≥ 2 M	≥ 2.5 M	≥ 3 M
Brightness	≥ 1,000 cd/m ²	≥ 1,000 cd/m ²	≥ 1,000 cd/m ²
Viewing Angle	140° (H)/140°(V)	140° (H)/140°(V)	140° (H)/140°(V)
Refresh rate	≥1,920 Hz (3840HZ optional)	≥1,920 Hz (3840HZ optional)	≥1,920 Hz (3840HZ optional)
Input voltage	AC90-240V	AC90-240V	AC90-240V
Maximum Power Consumption	1170Wper unit	750Wper unit	600W per unit
Average Power Consumption	350Wper unit	220Wper unit	280W per unit
Control method:	Asynchronous(WIFI/USB/LAN/HDMI)	Asynchronous (WIFI/USB/LAN/HDMI)	Asynchronous (WIFI/USB/LAN/HDMI)
Temperature Operating (°C)	-10°~+40°	-10°~+40°	-10°~+40°
Working Humidity	10%~95%RH	10%~95%RH	10%~95%RH
IP Rating	IP20	IP20	IP20
Certificate	CE/ROHS/FCC	CE/ROHS/FCC	CE/ROHS/FCC

TOTEM OUTDOOR SPECIFICATION

Model Type	P2.5 - 640x1920 mm	P3 - 576x1920 mm	P3 - 768x1920 mm
Application	Outdoor	Outdoor	Outdoor
Pixel pitch	2.5mm	3mm	3 mm
Density	160000	111111	111111
LED Type	SMD1415	SMD1921	SMD1921
Pixel type(R / G / B)	1R1G1B (3 in 1)	1R1G1B (3 in 1)	1R1G1B (3 in 1)
Module size	160 x 160mm	192 x 192 mm	192 x 192 mm
Module Resolution	64 x 64 pixel	64 x 64 pixel	64 x 64 pixel
LED Moudle layout(W×H)	4 x 12mm	3 x 10	4 x 10
Display Size	640*1920mm	576 x 1920mm	768 x 1920 mm
Display Resolution	256*768pixel	192 x 640pixel	256 x 640pixel
Display area	1.23m ²	1.11m ²	1.48m ²
Cabinet Size(mm)	643 x 1930mm	579 x 1930 mm	781 x 1930 mm
Resolution(W×H)	256 x 768	192x640	256 x 640
Case Material	Aluminum	Aluminum	Aluminum
Weight	45kg/unit	50kg /unit	55kg /unit
Drive mode	1/32scan	1/16scan	1/16scan
Viewing Distance	>2m	>3m	>3m
Brightness	5000 cd/m ²	5000 cd/ m ²	5000 cd/ m ²
Viewing Angle	140°/140°	140°/140°	140°/140°
Refresh rate	≥1920Hz	≥1920Hz	≥1920Hz
Input voltage	AC 240/100±10%	AC 240/100±10%	AC 240/100±10%
Maximum Power Consumption	1350W	1050W	1400W
Average Power Consumption	450W	315W	420W
Control method:	Asynchronous(WIFI/USB/LAN/HDMI)	Asynchronous(WIFI/USB/LAN/HDMI)	Asynchronous(WIFI/USB/LAN/HDMI)
Temperature Operating (°C)	-40°~+75°	-40°~+75°	-40°~+75°
Working Humidity	10%-90%	10%-90%	10%-90%
IP Rating	IP65	IP65	IP65
Certificate	CE/ROHS/FCC	CE/ROHS/FCC	CE/ROHS/FCC

RENTAL LED DISPLAY



Rental LED Screen
RS, RX, RX PRO
Indoor / Outdoor

▶ RS - SERIES

Top Handle

Power Plug

Side Handle

Fast Lock

Signal Plug



Front

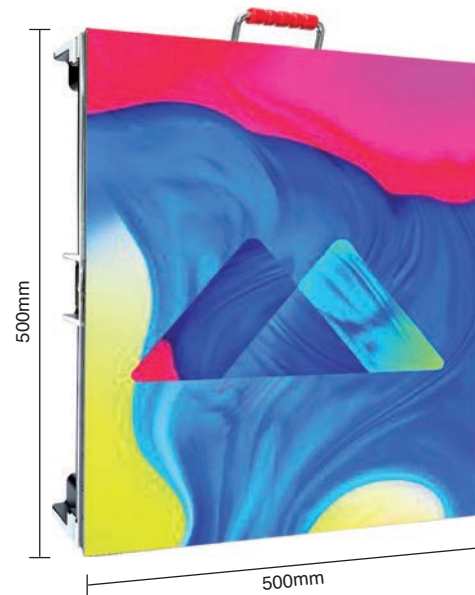

Side



TOTEM - indoor and outdoor LED display

▶ RX – SERIES

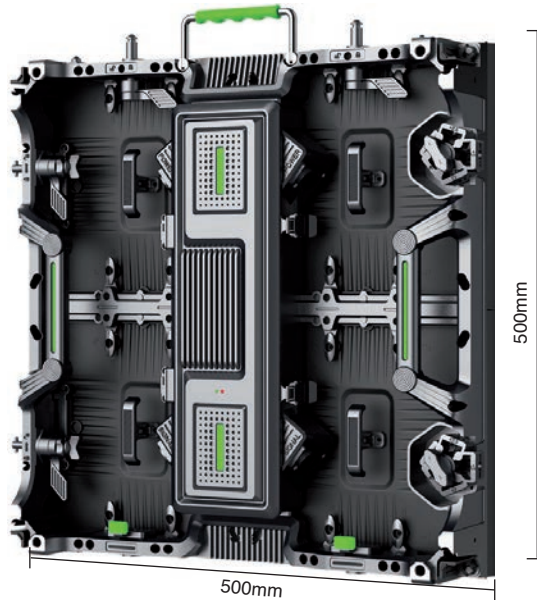
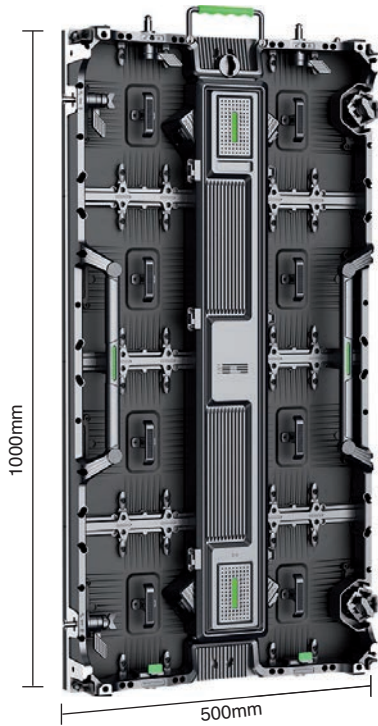

Ultra lightweight and super slim

Each module (standard cabinet size: 500*500mm and 500*1000mm) can be spliced into free compositions to meet the size requested by different projects and shapes.

Ultra-Lightweight die-casting aluminum with high precision junctions. Ultra-thin: only 75mm in depth. Easy to handle and to transport.

▶ RX PRO – SERIES

Cabinet Handle

Location Groove

Corner Protector for LED

Module Installation Knob

Top Fast Lock

Left Fast Lock

Power Connector

Power Box Bucklet

Cabinet Handle

Magnet Adsorption Module

Signal Connector

Module Handle

Left Fast Lock

Back

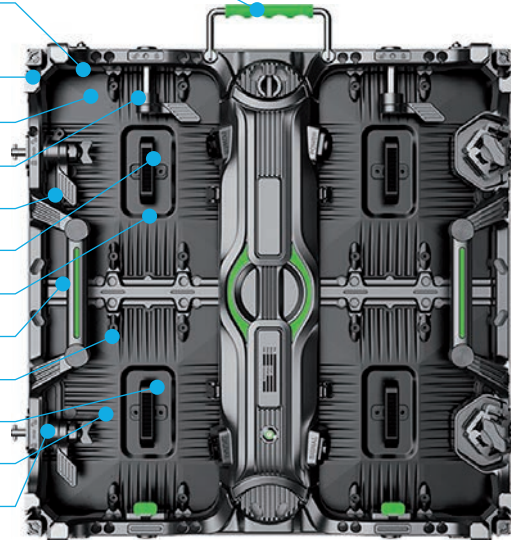

Front



▶ PRODUCT FEATURES

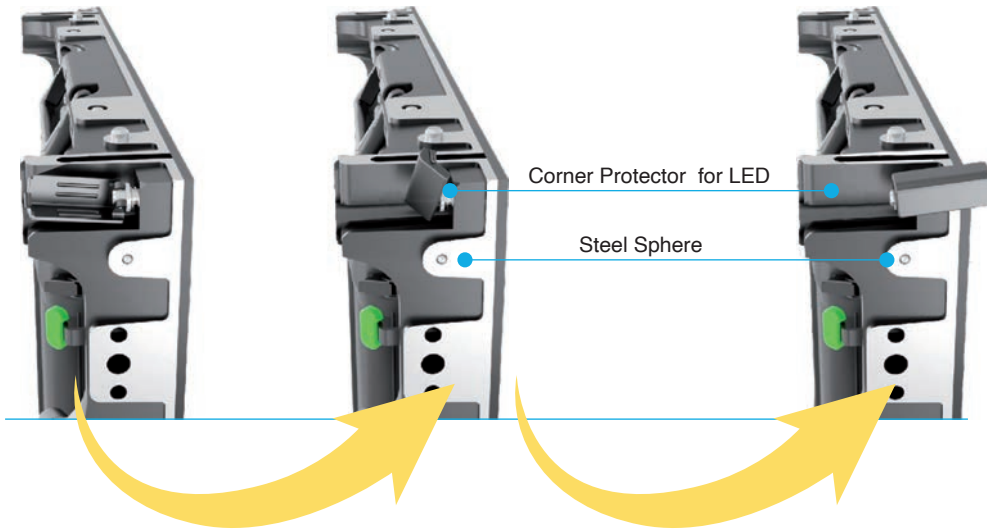

- ✓ Four corner protectors in each corner to prevent LED to be damaged.
- ✓ More security for transport, installation, operation, assemble & disassemble
- ✓ Modules are arranged regardless of left and right.
- ✓ Dual Service with Frontal and Rear Maintenance.



▶ PRODUCT FEATURES

Multiple Installation

- ▶ Hanging
- ▶ Wall-Mounted
- ▶ Ground Stacking
- ▶ Curved



Curve Lock (Curve Cabinet)



Outdoor

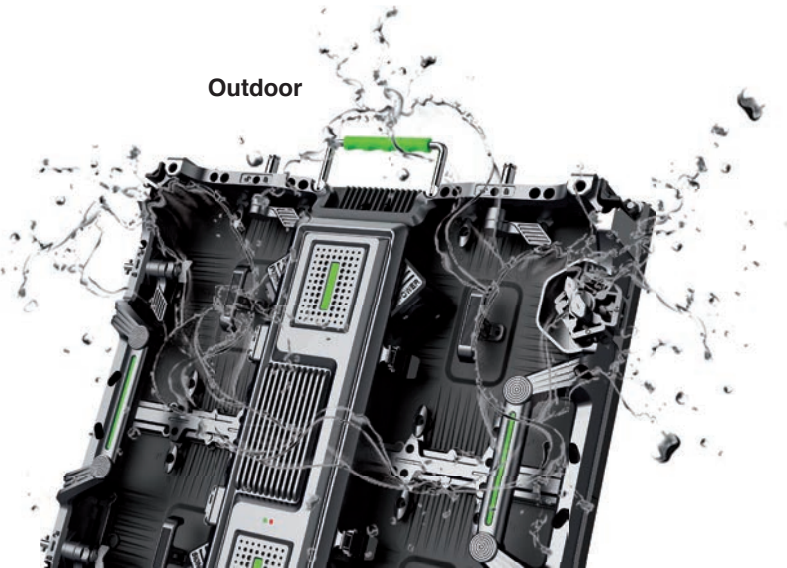

High Contrast



Modular Design



Low Noise



Easy Installation



Bright colors



Wide View

RENTAL LED DISPLAY SPECIFICATION

Type	Rental LED Display					
Model:	IR-P1.9	IR-P2.6	IR-P2.976	IR-P3.91	OR-P3.91	OR-P 4.81
Application	Indoor				Outdoor	
Pixel pitch	1.9mm	2.6mm	2.976mm	3.91mm	3.91mm	4.81mm
Destiny	262,114 Dots/M2	147,456 Dots/M2	112,896 Dots/M2	655,36 Dots/M2	655,36 Dots/M2	43,264 Dots/M2
LED Type	SMD1010	SMD1515	SMD2121	SMD2121	SMD1921	SMD2727
Pixel type(R / G / B)	1R1G1B (3 in 1)	1R1G1B (3 in 1)	1R1G1B (3 in 1)	1R1G1B (3 in 1)	1R1G1B (3 in 1)	1R1G1B (3 in 1)
Module size	250*250mm	250*250mm	250*250mm	250*250mm	250*250mm	250*250mm
Module Resolution	128*128 Pixel	96*96 Pixel	84*84 Pixel	64*64 Pixel	64*64 Pixel	52*52 Pixel
Cabinet Size (H*W)	500*500mm	500*500mm	500*500mm	500*500mm	500*500mm	500*500mm
Cabinet Resolution (PX* PX)	256*256 Pixel	192*192 Pixel	168*168 Pixel	128*128 Pixel	64*64 Pixel	52*52 Pixel
Cabinet Size (H*W)	500*1000mm	500*1000mm	500*1000mm	500*1000mm	500*1000mm	500*1000mm
Cabinet Resolution (PX* PX)	256*512 Pixel	192*384 Pixel	168*336 Pixel	128*256 Pixel	128*256 Pixel	52*104 Pixel
Drive mode	1/32 scan	1/16 scan	1/32 scan	1/16 scan	1/16 scan	1/13 scan
Weight	7/13 KG	7/13 KG	7/13 KG	7/13 KG	7/13 KG	7/13 KG
Viewing Distance	> 1m	> 1m	> 2m	> 3m	> 3m	> 4m
Brightness	1000nits	1000nits	1000nits	1000nits	4500nits	4500nits
IP Rating	IP43	IP43	IP43	IP43	IP65	IP65
Maximum Power Consumption	680W	660W	650W	600W	700W	740W
Average Power Consumption	200W	210W	195W	180W	210W	220W
Case Material	Die-casting aluminum	Die-casting aluminum	Die-casting aluminum	Die-casting aluminum	Die-casting aluminum	Die-casting aluminum
Viewing Angle	140° (H)/140°(V)	140° (H)/140°(V)	140° (H)/140°(V)	140° (H)/140°(V)	140° (H)/140°(V)	140° (H)/140°(V)
Input voltage	110-220V	110-220V	110-220V	110-220V	110-220V	110-220V
Grey Scale (bit)	16bit	16bit	16bit	16bit	16bit	16bit
Refresh rate(HZ)	1920 or 3840 optional	1920 or 3840 optional	1920 or 3840 optional	1920 or 3840 optional	1920 or 3840 optional	1920 or 3840 optional
Control method:	Sync&Async	Sync&Async	Sync&Async	Sync&Async	Sync&Async	Sync&Async
Temperature Operating (°C)	-20°C~+80°C	-20°C~+80°C	-20°C~+80°C	-20°C~+80°C	-20°C~+80°C	-20°C~+80°C
Working Humidity	10%RH-90%RH	10%RH-90%RH	10%RH-90%RH	10%RH-90%RH	10%RH-90%RH	10%RH-90%RH
Services access	Dual (Front and Rear)	Dual (Front and Rear)	Dual (Front and Rear)	Dual (Front and Rear)	Dual (Front and Rear)	Dual (Front and Rear)
Certificate	CE/ROHS/FCC	CE/ROHS/FCC	CE/ROHS/FCC	CE/ROHS/FCC	CE/ROHS/FCC	CE/ROHS/FCC



OUTDOOR LED DISPLAY



Front Maintenance
LED Display

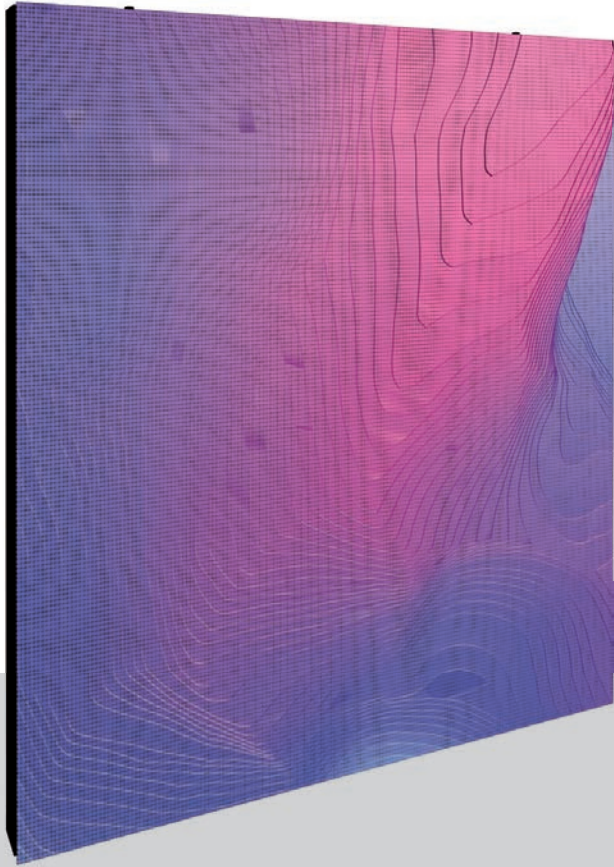

NSELED offers seamless large-format digital visual display in a variety of resolutions, providing clear and detailed images and vivid colors to every business communication style.

NSELED Outdoor LED signage is designed to adapt to any weather conditions, delivering peak performance in every situation.

- Waterproof (IP65 grade)
- High brightness: over 6000 nits
- Low power consumption
- Low heat emission



▶ LOWER POWER CONSUMPTION

Each NSELED LED module is designed to improve energy efficiency significantly without affecting the overall visual experience.

High-quality LED lights have a good heat dissipation system, which prolongs the life of the LED lights.

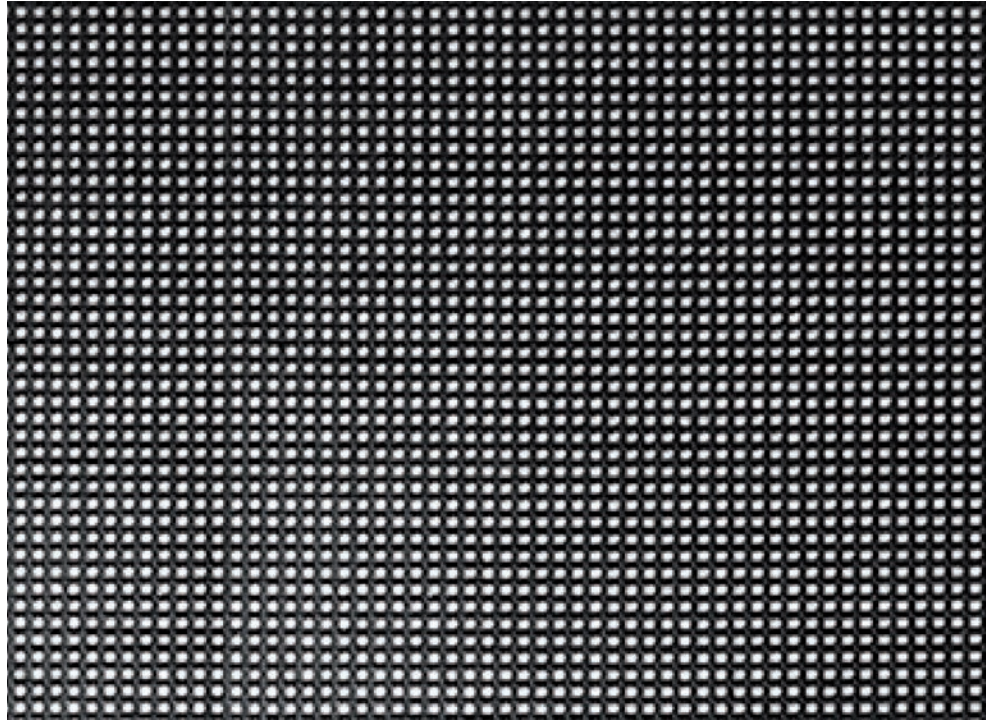

▶ BOTH FRONT AND REAR SERVICES



1) The assembly and disassembly process is very simple, which can save a lot of time and cost for future maintenance.

2) The front maintenance of the LED screen module greatly reduces the overall thickness of the LED screen structure, thus saving installation space.



▶ ULTRA SLIM AND LIGHT CABINET

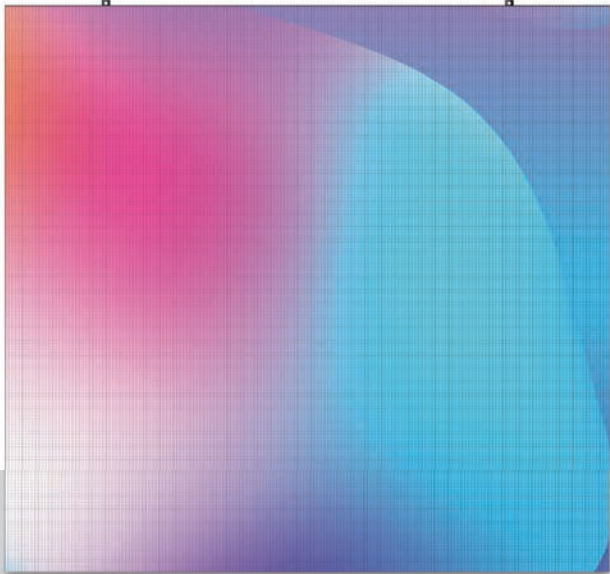

▼
Lighter Weight And Thinner Cabinet

Add less burden to the wall or building surface, offering a refined finish to the structure

▼
With Bevel Angle On Modules 90-180°
Allow creative shapes of installation to meet different project requirements.

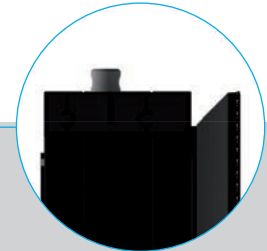

▶ APPLICATION CASE

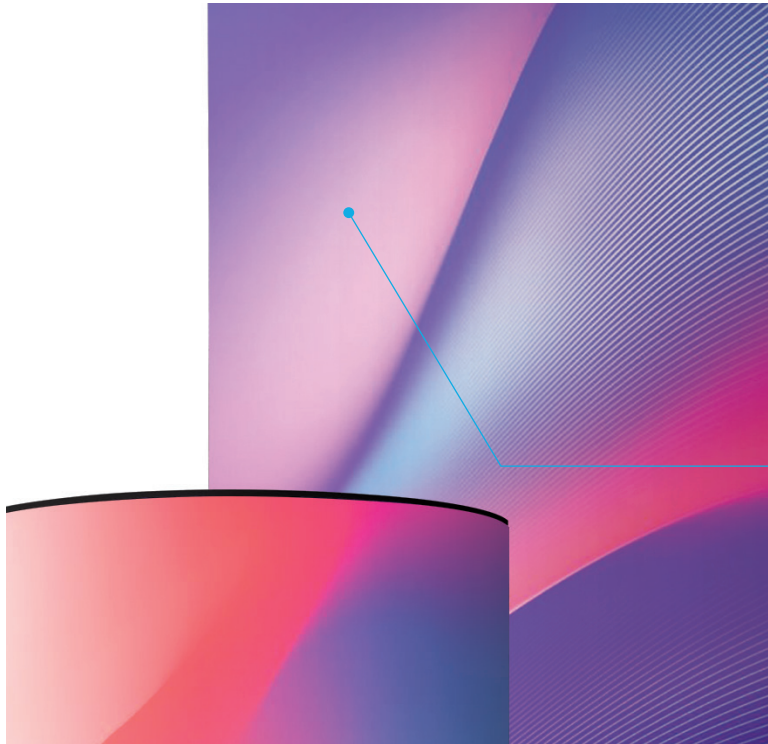

NSELED Outdoor LED signage is a mind-blowing eye catcher, conceived to deliver outstanding advertising content and incredible visual experiences to passers-by.

It can be widely used in airport terminals, shopping malls, exhibition centers, movie theaters, etc.

▶ SMART AND USER-FRIENDLY



Simple to use, you can control this display and upload content via your PC, even if you do not have particular skills in IT.

▶ STANDARD CABINET

Outdoor LED Signage's standard pixel pitch is P4 - 4mm (other models are available on order).

The measures of the P4 Cabinet are:

V64 COMPATIBILI FRA LORO

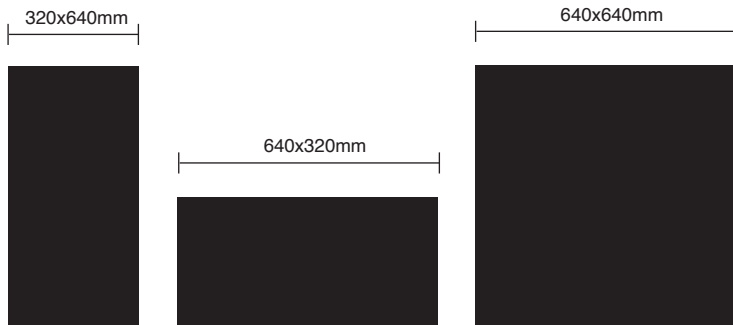

V96 COMPATIBILI FRA LORO

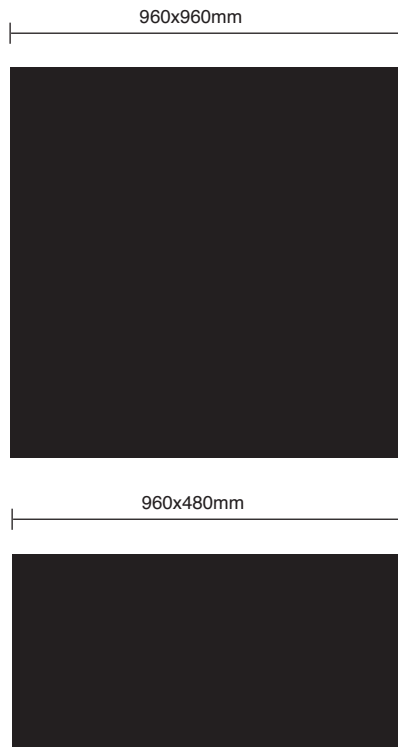

**Double-sided LED
flag sign**



**Double-sided LED
pole display**



**Shop-window LED display
(outdoor or semi-outdoor)**



**Outdoor Retail LED
Signage**



**Outdoor LED display
(poster type)**



OUTDOOR LED DISPLAY SPECIFICATION

STANDARD IN STOCK

Model Type	OF-P2.5	OF-P3	OF-P4	OF-P5	OF-P6	OF-P8	OF-P10
Application	Outdoor	Outdoor	Outdoor	Outdoor	Outdoor	Outdoor	Outdoor
Pixel pitch	2.5mm	3mm	4mm	5mm	6mm	8mm	10mm
Density	160,000 dot/ m2	111,111 dot/ m2	625,00 dot/ m2	40,000 dot/ m2	277,78 dot/ m2	156,25 dot/ m2	100,00 dot/ m2
LED Type	SMD2121	SMD2121	SMD1921	SMD2525	SMD3535	SMD3535	SMD3535
Pixel type(R / G / B)	1R1G1B (3 in 1)	1R1G1B (3 in 1)	1R1G1B (3 in 1)	1R1G1B (3 in 1)	1R1G1B (3 in 1)	1R1G1B (3 in 1)	1R1G1B (3 in 1)
Module size	320*160mm	192*192mm	320*160mm	160*160mm	192*192mm	256*128mm 320*160mm	320*160mm
Module Resolution	128*64pixel	61*64pixel	80*40 pixel	32*32 pixel	32*32pixel	32*16 pixel 40*20pixel	32*16 pixel
Case Material	Aluminum / Iron	Aluminum / Iron	Aluminum	Aluminum / Iron	Aluminum / Iron	Aluminum / Iron	Aluminum / Iron
Drive mode	1/32 Scan	1/16 Scan	1/16 Scan	1/8 Scan	1/4 Scan	1/4 Scan	1/2 Scan
Viewing Distance	2-150m	3-150m	4-150m	5-150m	6-150m	8-150m	10-150m
Brightness	≥5000 nit	≥5000 nit	≥6000 nit	≥6000 nit	≥6500 nit	≥6500 nit	≥6500 nit
Refresh rate	≥3840	≥3840	≥3840	≥3840	≥3840	≥3840	≥3840
Input voltage	110-220V	110-220V	110-220V	110-220V	110-220V	110-220V	110-220V
Maximum Power Consumption	1200w	1040w	800w	800w	1040w	850w	900w
Average Power Consumption	380w	360w	240w	240w	360w	280w	300w
Temperature Operating (°C)	-25°C ~45°C	-25°C ~45°C	-25°C ~45°C	-25°C ~45°C	-25°C ~45°C	-25°C ~45°C	-25°C ~45°C
Working Humidity	10% ~95%	10% ~95%	10% ~95%	10% ~95%	10% ~95%	10% ~95%	10% ~95%
IP Rating	IP65	IP65	IP65	IP65	IP65	IP65	IP65
Viewing Angle	140° (H)/140°(V)	140° (H)/140°(V)	140° (H)/140°(V)	140° (H)/140°(V)	140° (H)/140°(V)	140° (H)/140°(V)	140° (H)/140°(V)
Control method:	Asynchronous &Synchronous	Asynchronous &Synchronous	Asynchronous &Synchronous	Asynchronous &Synchronous	Asynchronous &Synchronous	Asynchronous &Synchronous	Asynchronous &Synchronous
Certificate	CE/ROHS/FCC	CE/ROHS/FCC	CE/ROHS/FCC	CE/ROHS/FCC	CE/ROHS/FCC	CE/ROHS/FCC	CE/ROHS/FCC
			FRONT MAINTENANCE				

INDOOR LEDWALL



Indoor
high-performance display
Modular system



Intelligent adjustable high brightness
High gray level and better color performance
High contrast, faster response speed
and high refresh frequency



Indoor video walls can create a spectacular impact to passers-by and reinforce any brand communication. NSELED LED system delivers excellent picture quality even at close range and at a wide viewing angle.



▶ FAST&EASY TO UPDATE

NSELED LEDwalls are user-friendly. Thanks to an A4 controller, they support LAN, WIFI, USB and HDMI connection. A CLOUD allows you to upload content and update displays remotely.

With an Indoor LED screen you have the possibility to display high-resolution images and videos in public spaces such as exhibitions, museums, retail stores, theatres, education facilities and security monitoring rooms.



▶ DESIGNED TO LAST

- Energy saving
- Long life span
- High image definition
- High-quality LED lamp beads

Seamless splicing due to precision joints
and refined details

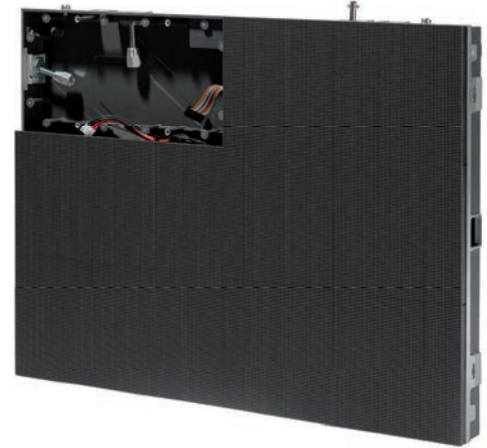

▶ INDOOR LEDWALL SPECIFICATIONS

Indoor wall mounted WA series				
Model Type	P2	P2.5	P3 076	P4
Application	Indoor	Indoor	Indoor	Indoor
Module size	320*160mm	320*160mm	320*160mm	320*160mm
Brightness	1000 nit	1000 nit	800 nit	800 nit
Scan	1/40	1/32	1/26	1/20
Remarks	3840HZ (Hight Refresh Rate) with Magnet	3840HZ (Hight Refresh Rate) with Magnet	3840HZ (Hight Refresh Rate) with Magnet	3840HZ (Hight Refresh Rate) with Magnet

WA Series			
640x480 mm	640x640 mm	320x640 mm	960x480 mm

Indoor wall mounted WS series				
Model Type	P1 953	P2 604	P2 976	P3 91
Application	Indoor	Indoor	Indoor	Indoor
Module size	250*250mm	250*250mm	250*250mm	250*250mm
Brightness	1000 nit	1000 nit	1000 nit	800 nit
Scan	1/32	1/32	1/28	1/16
Remarks	3840HZ (Hight Refresh Rate) with Magnet	3840HZ (Hight Refresh Rate) with Magnet	3840HZ (Hight Refresh Rate) with Magnet	3840HZ (Hight Refresh Rate) with Magnet

WS Series		
500x500 mm	1000x250 mm	1000x500 mm

SLIM TAXI LED DISPLAY

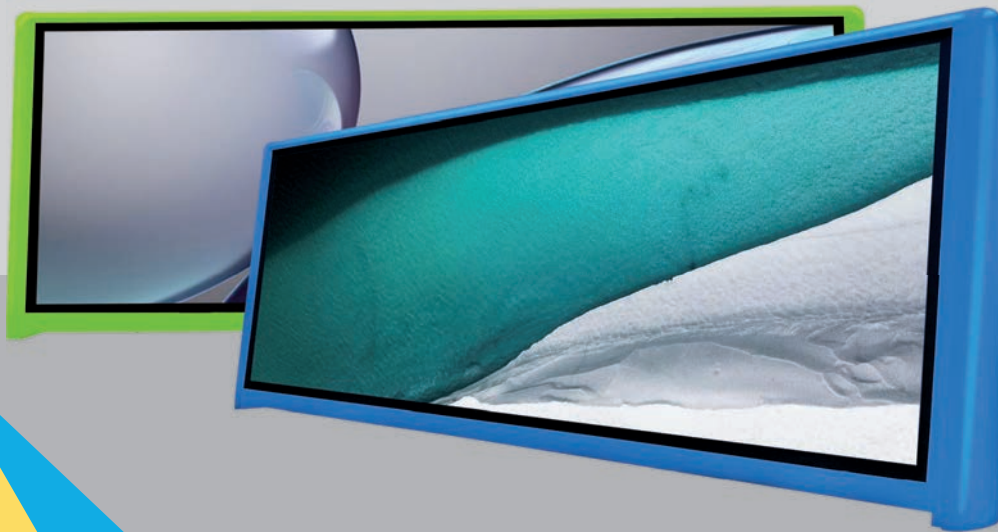

Car Top LED Display
LED Motion
ULTRA THIN VERSION

Slim Type Design, Super High Brightness, Ultra High Definition, HD performance

Different Pixel Pitch Available

2.5 mm	5500 nits
3.33 mm	5000 nits
5mm	5000 nits



▶ CASE



▼
SLIM TAXI LED DISPLAY

▶ RELIABLE LED MOTION DEVICE

High Quality And Stable LED Components
The High Refresh Rate Driving IC

▶ Lower Power Consumption

High-Quality Materials And Parts

▶ The LED display is firmly attached to the car

Vehicle Dedicated Power Supply

▶ Ensure the highest performance of LED Panel and keep the whole system running.



▶ QUALITY CONTROL TEST

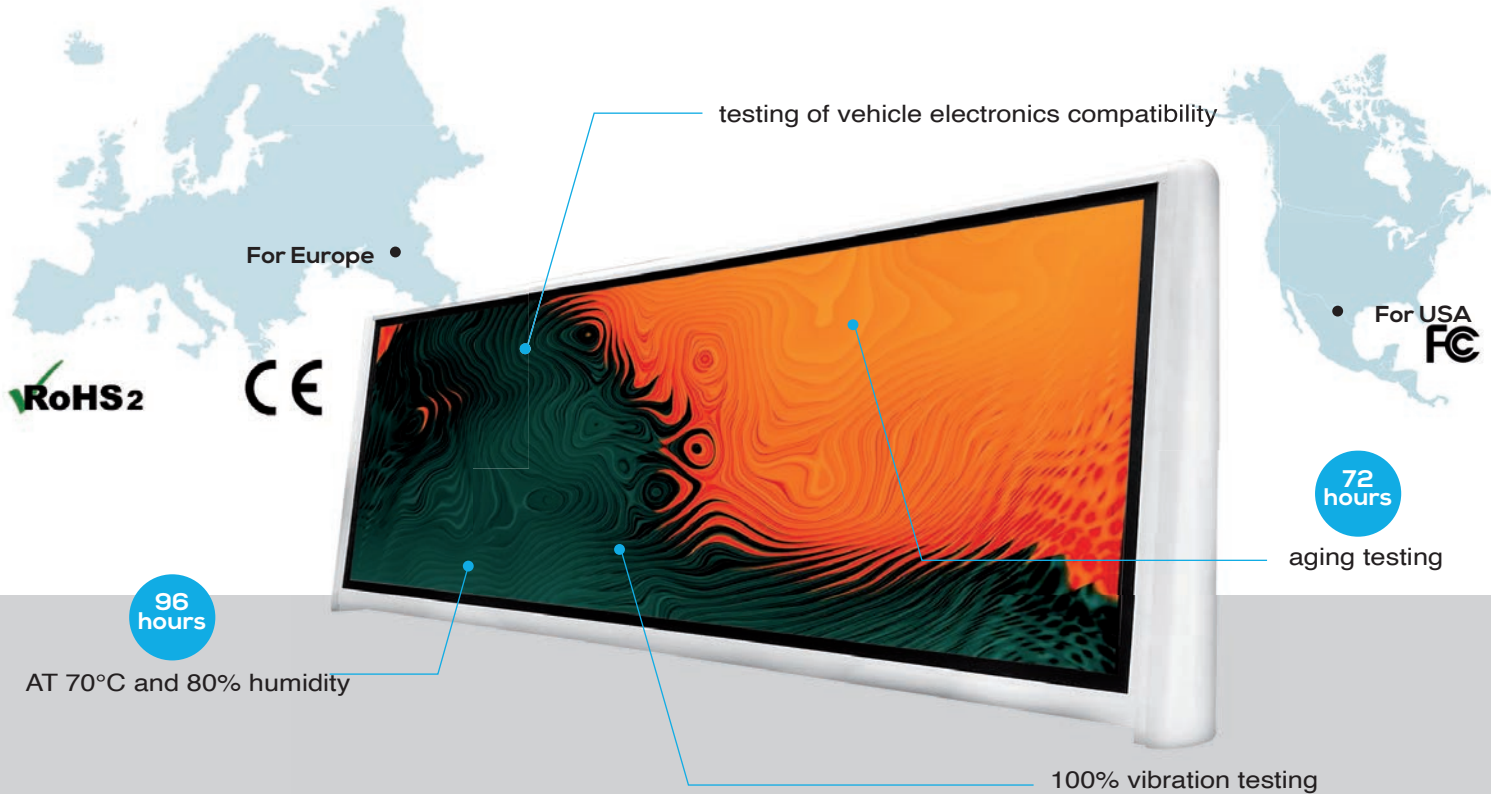

▶ MULTIPLE CONTROL METHODS

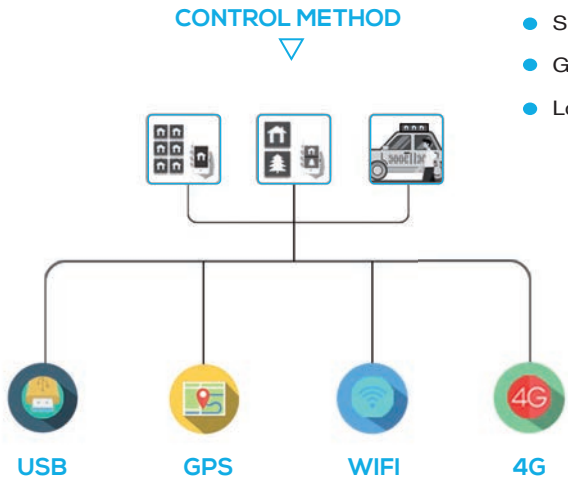

- Smart Asynchronous Controller
- Group Intelligent Control(GIC System)
- Location Precise Advertising



Car Rack available to install the display on different types of cars

▶ SLIM TAXI LED DISPLAY SPECIFICATION

Product name	P2.5	P3.33	P5
Model Type	SLIM P2.5	SLIM P3.33	SLIM P5
Pixel Pitch	2.5 mm	3.33 mm	5mm
LED Type	SMD2121	SMD 1921	SMD 2727
Pixel Density	160,000 dot/ m2	90,000 dot/ m2	40000 dot/ m2
Module Size	160*160mm	320*160mm	160*160mm
Screen Size	960mm*320mm	960mm*320mm	960mm*320mm
Screen Resolution	384*128 dot	288*96 dot	192*64 dot
Frame Size	1100mm(L) x 410mm(H) XW:164mm(bottom)/ 99mm (top)	1100mm(L) x 410mm(H) XW:164mm(bottom)/ 99mm (top)	1100mm(L) x 410mm(H) XW:164mm(bottom)/ 99mm (top)
Brightness	5500 nit	5000 nit	5000 nit
Contrast	8000:01:00	8000:01:00	8000:01:00
View Angle	150°(H)/150°(V)	150°(H)/150°(V)	150°(H)/150°(V)
Scan Mode	1/32 scan	1/24 scan	1/8 scan
Power Supply Input	DC9--24V	DC9--24V	DC9--24V
Max Consumption	430w	400w	450w
Average Consumption	120w	120w	150w
Refresh Rate(Hz)	1920Hz / 3840 Hz(Optional)	1920Hz	1920Hz
Optimal Viewing Distance	1--20M	1--20M	3--50M
Life Span	100,000 Hours	100,000 Hours	100,000 Hours
MTBF	10,000 Hours	10,000 Hours	10,000 Hours
Control Method	Asynchronous	Asynchronous	Asynchronous
Control Mode	3G/4G/WIFI/ Ethernet/ USB	3G/4G/WIFI/ Ethernet/ USB	3G/4G/WIFI/ Ethernet/ USB
Temperature Operating	-40°~+75°	-40°~+75°	-40°~+75°
Working Humidity	10%~90%RH	10%~90%RH	10%~90%RH
Protection Rating	IP65	IP65	IP65
Power Protection	over-temperature/over-current/ over-voltage protection	over-temperature/over-current/ over-voltage protection	over-temperature/over-current/ over-voltage protection
Screen Weight	19 kg	19 kg	19 kg
Package Dimension	1100mm(L) X 500mm(H) X 270mm (W)	1100mm(L) X 500mm(H) X 270mm (W)	1100mm(L) X 500mm(H) X 270mm (W)
Gross Weight	24 kg	24 kg	24 kg
Certificates	CE/ROHS/FCC	CE/ROHS/FCC	CE/ROHS/FCC



FLEXIBLE LED DISPLAY



Creative LED Display
Soft LED Module



High Image Quality&Perfect Visual Enjoyment

The flexible LED screen available 2mm, 2.5mm, 3mm, and 4mm resolutions offers a better-quality image with high refresh rate, enhancing contrast, providing color uniformity and superior black levels.

Also,the Flexible LED panel because of its special shape design, gives audiences a perfect visual enjoyment, favored by the majority of customers.



▶ KEY FEATURES

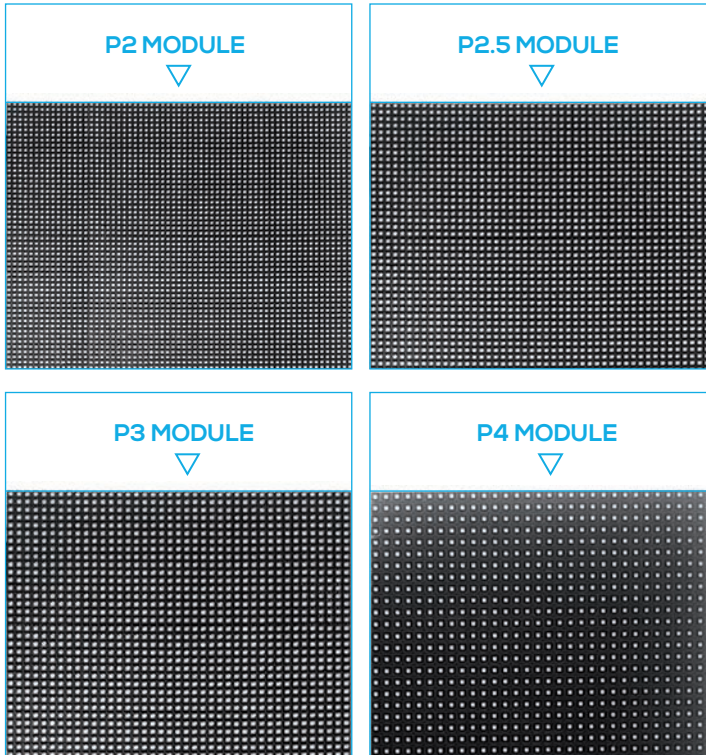

- A better-quality image with suitable brightness
- Enhancing contrast
- Providing color uniformity
- Superior black levels
- Seamless splicing

▶ KEY FEATURES

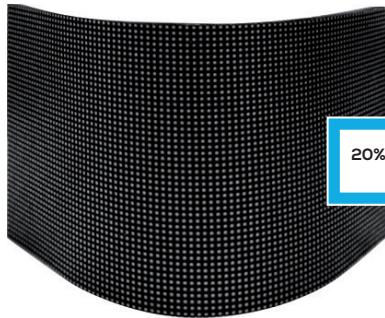

△
HIGH FLEXIBILITY

Light weight

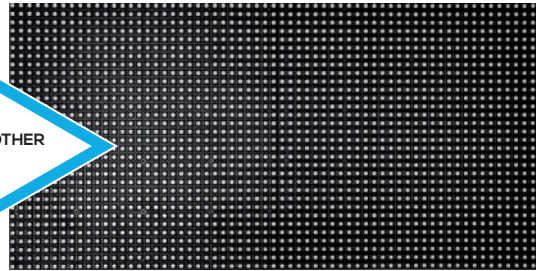

△
NORMAL LED PANEL

20% LIGHTER THAN OTHER
CABINET LED

Easy to Install and Maintain

- 1) High flexibility: It can be made in any sizes and shapes for creative installations.
- 2) Easy to splice: Magnet design LED panel makes the screen easy to assemble and disassemble.
- 3) Front maintenance: It is very easy to maintain and replace by end-users.
- 4) Light weight: Saving 50% shipping and installation costs.

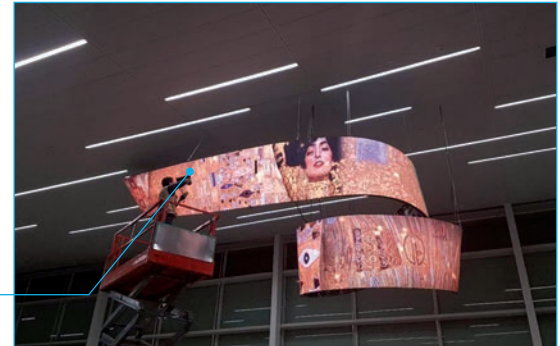

▶ CUSTOMIZATION SERVICE

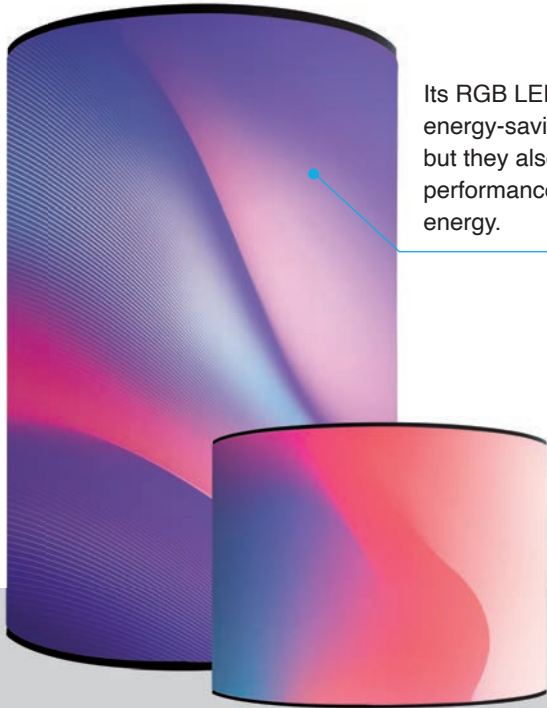

Its RGB LED diodes are not only energy-saving, but they also have excellent performance while saving energy.

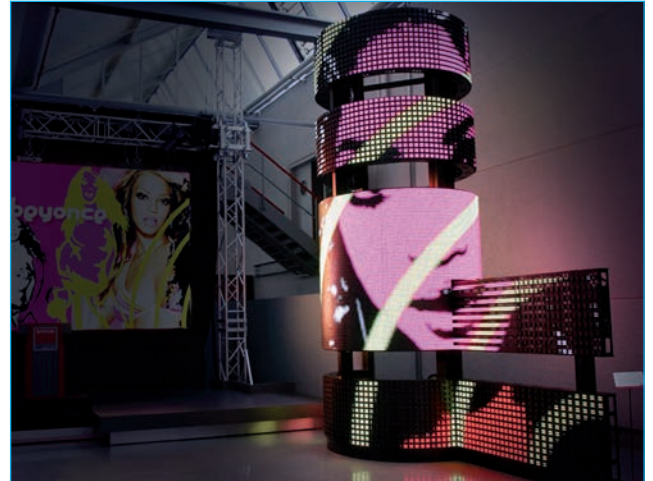

The flexible led screen can use for many applications, such as: hotel advertising, exhibitions, stage rental, tv studios, shopping malls, airports, outdoor stadiums, concerts, KTV, playgrounds, etc.

FLEXIBLE LED DISPLAY SPECIFICATION

Model Type	P2.5	P3	P4
Application	Indoor	Indoor	Indoor
Pixel pitch	2.5mm	3 mm	4mm
Destiny	160000 Dots/M2	111111 Dots/M2	62500 Dots/M2
LED Type	SMD1010	SMD1515	SMD2121
Pixel type(R / G / B)	1R1G1B (3 in 1)	1R1G1B (3 in 1)	1R1G1B (3 in 1)
Module size	240*120mm	240X120	256*128mm
Module Resolution	96*48dot	80X40dot	64*32dot
Module Weight	0.17kg	0.17kg	0.2kg
Power consumption	Max: 25W/pc	Max: 25W/pc	Max: 25W/pc
Drive mode	1/24 scan	1/20 scan	1/16 scan
Driving IC	MBI5124	MBI5124	MBI5124
Viewing Distance	2.5m	3m	4m
Brightness	1100cd/M2	1100cd/M2	1100cd/M2
Viewing Angle	140°(H)/140°(V)	140°(H)/140°(V)	140°(H)/140°(V)
Refresh rate	1920Hz	1920Hz	1920Hz
Input voltage	AC 220/110±15%	AC 220/110±15%	AC 220/110±15%
MTBF	≥ 10,000 hs	≥ 10,000 hs	≥ 10,000 hs
Grey Level	14 Bits	14 Bits	14 Bits
Control method:	Asynchronous & Synchronous	Asynchronous & Synchronous	Asynchronous & Synchronous
Temperature Operating (°C)	-20 °C ~ +60 °C	-20 °C ~ +60 °C	-20 °C ~ +60 °C
Working Humidity	10%~95%	10%~95%	10%~95%
IP Rating	IP43	IP43	IP43
Certificate	CE,ROHS	CE,ROHS	CE,ROHS

OUTDOOR ROUNDED SIGN



Double-sided LED display

Our Circle display is a rounded, double-sided LED display, P3mm outdoor, the evolution 2.0 of the traditional flag sign. Bright and catchy, this product is perfect if you want to attract customers from a long distance and make your business the star of the street!

The Circle LED display is a mind-blowing eye catcher in all climatic conditions: waterproof (IP65 level) and sturdy, each display is carefully refined with polycarbonate covers.



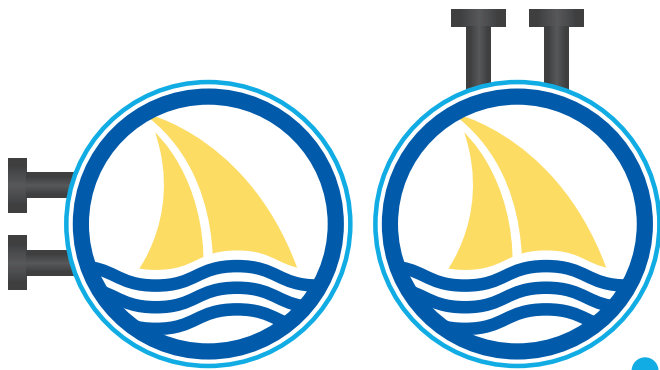

Simple to use, you can control this display and upload content via your PC or a smartphone, even if you do not have particular skills in IT.

Two possible installations: horizontal or in suspension, so that the passers-by can enjoy your advertisement simultaneously from both sides of the street!

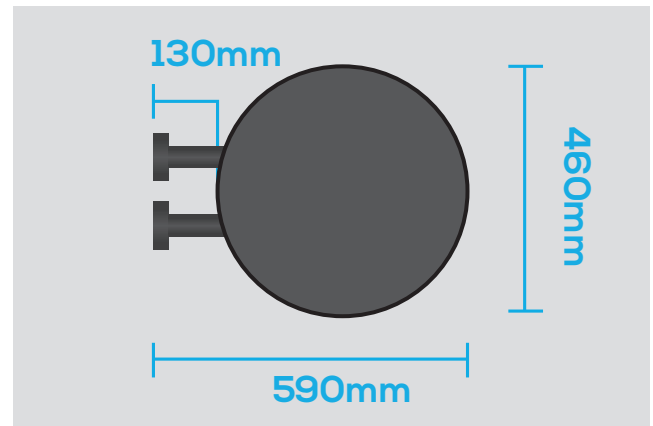
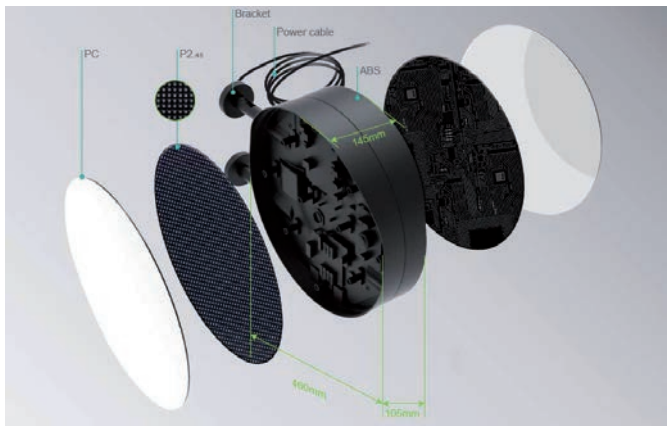

▶ OUTDOOR ROUNDED SIGN SPECIFICATION

Model Type	P3
Pixel pitch	P2.96mm
Color value	>16.7mln
Color temperature	8500K
Drive mode	constant voltage
Frame change	frequency 60Hz
White-balance brightness	>3500cd/m2
Working environment	-20°C~40°C
Brigtness adjustmte	level 256 (system can be set)
Average trouble-free time	>1000h
Screen weight	7kg
Control system	NOVA system
Control mode	asynchronous/WIFI
Video memory	4BG
Video format	AVI, MKV, MP4, MOV, 3GP, TS, FLV
Scan mode	1/19 scan
Optimal sight distance	≥ 3mm
Maximum power	≥ 160W
Average power	70W
Grayscale level	14bits
Refresh Rate	≥ 1920Hz
Input voltage	90~264V
Blind spot rate	>0.0001
IP Grade	IP65
Life Span (50% brightness)	≥100000h
Built-in	Meanwell or the same configuration
Shell	ABS anti-UV
Transparent cover mode	PC
Installation mode	side mounted



MAGIC CUBE LED DISPLAY



Creative LED Cube Sign
Four/Five Faces

NSELED Magic Cube is the digital evolution of advertising flag sign, crafted to enhance brand awareness.

Multi-sided HD LED display (4-sided or 5-sided display) with a variety of sizes to choose from.

640x640x640mm



480x480x408mm



320x320x320mm



▶ MAIN FEATURES

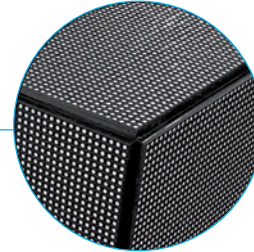

The Magic Cube LED sign has the advantages of lightweight, good wind resistance, easy installation, water-proof performance.

No need for professional installation.

Plug and play device.

User- friendly: even the end-user can easily operate the LED cube screen via computer or mobile phone app.

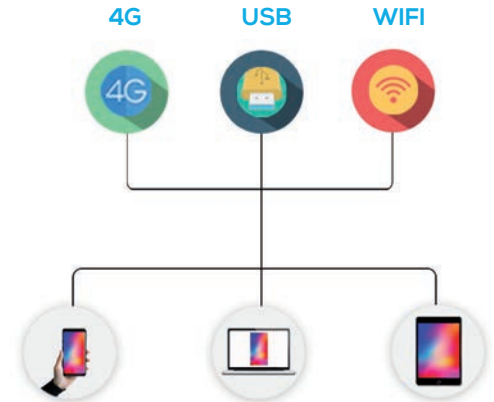

▶ INSTALLATION METHOD



△
Hanging



△
Wall-Mounted



▶ NUMEROUS APPLICATIONS



NSELED Magic Cube is a high-visibility promotional tool for events, businesses and services as they're placed outside, or in an optimal location outside businesses, to advertise brand messages, events and offers.

MAGIC CUBE LED DISPLAY SPECIFICATION

Type	Outdoor Magic Cube LED display			
Model:	LC303	LC305	LC204	LC206
Application environment	Outdoor	Outdoor	Outdoor	Outdoor
Pixel Pitch	P3	P3	2.5mm	2.5mm
Pixel Configuration	SMD 1921	SMD 1921	SMD 1415	SMD 1415
Pixel Density	111,111 pixels/m ²	111,111 pixels/m ²	160,000 pixels/m ²	160,000 pixels/m ²
Scan Method	1/16 Scan	1/16 Scan	1/16 Scan	1/16 Scan
Module Dimensions (W × H)	192*192mm	192*192mm	160*160mm	160*160mm
Module resolution	64*64 dots	64*64 dots	64*64 dots	64*64 dots
Screen size	384 × 384mm / side	576 × 576mm / side	480 × 480mm / side	640 × 640mm / side
Screen resolution	128*128 dots	192*192 dots	192*192 dots	256*256 dots
Module quantity	4 pcs / side	9 pcs / side	9 pcs / side	16 pcs / side
Screen design	5 sided / 4 sided (optional)	5 sided / 4 sided (optional)	5 sided / 4 sided (optional)	5 sided / 4 sided (optional)
Case Material	Steel / Aluminum	Steel / Aluminum	Steel / Aluminum	Steel / Aluminum
Weight	23kg/ set	32kg/ set	25kg/ set	40kg/ set
Colours	281 trillion	281 trillion	281 trillion	281 trillion
Contrast Ratio	2,000 : 1	2,000 : 1	2,000 : 1	2,000 : 1
Average Power Consumption	200W / set	300W / set	240W / set	360W / set
Max Power Consumption	600W / set	800W / set	800W / set	1200W / set
Brightness	≥5000 nits	≥5000 nits	≥5500 nits	≥5500 nits
Refresh Rate	>1,920 Hz	>1,920 Hz	>1,920 Hz	>1,920 Hz
Horizontal Viewing Angle	140°	140°	140°	140°
Vertical Viewing angle	140°	140°	140°	140°
Expected Lifetime	100, 000 Hrs	100, 000 Hrs	100, 000 Hrs	100, 000 Hrs
Operating Temp/Humidity	-20°C-50°C / 10%-90%	-20°C-50°C / 10%-90%	-20°C-50°C / 10%-90%	-20°C-50°C / 10%-90%
Servicing	Rear	Rear	Rear	Rear
IP Rating	IP 65	IP 65	IP 65	IP 65
Control method	USB/WIFI /4G (optional)	USB/WIFI /4G (optional)	USB/WIFI /4G (optional)	USB/WIFI /4G (optional)
Accessories	Wall mounted kit	Wall mounted kit	Wall mounted kit	Wall mounted kit
Package:	Honey box	Honey box	Honey box	Honey box + wooden box



MAGIC CUBE LED DISPLAY SPECIFICATION

Type	Indoor P2.5 Magic Cube LED display		
Model:	LC213	LC214	LC216
Application environment	Indoor	Indoor	Indoor
Pixel Pitch	2.5mm	2.5mm	2.5mm
Pixel Configuration	SMD 2121	SMD 2121	SMD 2121
Pixel Density	160,000 pixels/m ²	160,000 pixels/m ²	160,000 pixels/m ²
Scan Method	1/32 Scan	1/32 Scan	1/32 Scan
Module Dimensions (W × H)	160*160mm	160*160mm	160*160mm
Module resolution	64*64 dots	64*64 dots	64*64 dots
Screen size	320 × 320mm / side	480 × 480mm / side	640 × 640mm / side
Screen resolution	128*128 dots	192*192 dots	256*256 dots
Module quantity	4 pcs / side	9 pcs / side	16 pcs / side
Screen design	5 sided / 4 sided (optional)	5 sided / 4 sided (optional)	5 sided / 4 sided (optional)
Case Material	Steel / Aluminum	Steel / Aluminum	Steel / Aluminum
Weight	13kg/ set	22kg/ set	36kg/ set
Colours	281 trillion	281 trillion	281 trillion
Contrast Ratio	2,000 : 1	2,000 : 1	2,000 : 1
Average Power Consumption	100W / set	160W / set	250W / set
Max Power Consumption	350W / set	550W / set	810W / set
Brightness	≥800 nits	≥800 nits	≥800 nits
Refresh Rate	>1,920 Hz	>1,920 Hz	>1,920 Hz
Horizontal Viewing Angle	140°	140°	140°
Vertical Viewing angle	140°	140°	140°
Expected Lifetime	100,000 Hrs	100,000 Hrs	100,000 Hrs
Operating Temp/Humidity	-20°C-50°C / 10%-90%	-20°C-50°C / 10%-90%	-20°C-50°C / 10%-90%
Servicing	Rear/ Front (optional)	Rear/ Front (optional)	Rear/ Front (optional)
IP Rating	IP 33	IP 33	IP 33
Control method	USB/WIFI /4G (optional)	USB/WIFI /4G (optional)	USB/WIFI /4G (optional)
Accessories	Wall mounted kit/ Hanging bar	Wall mounted kit/ Hanging bar	Wall mounted kit/ Hanging bar
Package:	Honey box	Honey box	Honey box +wooded box

NSELED Europe srl
Via Marco d'Agate, 41/B
20139 Milano Italia
info@nseled.eu
T. 02 40707210



For more information
www.nseled.eu

